

# PRESENTATION ON UTILIZATION OF ELECTRICAL ENERGY

5<sup>TH</sup> SEMESTER-ELECTRICAL ENGINEERING

Arvinder Singh, Lecturer  
Electrical Engg. Department  
GOVT. POLYTECHNIC SIRSA

# CONTENTS

## **1. Electric Heating**

- ▶ 1.1 Advantages of electrical heating
- ▶ 1.2 Heating methods:
  - ▶ 1.2.1 Resistance heating – direct and indirect resistance heating, electric ovens, their temperature range, properties of resistance heating elements, domestic water heaters and other heating appliances, thermostat control circuit
  - ▶ 1.2.2 Induction heating; principle of core type and coreless induction furnace, their construction and applications
  - ▶ 1.2.3 Electric arc heating; direct and indirect arc heating, construction, working and applications of arc furnace
  - ▶ 1.2.4 Dielectric heating, applications in various industrial fields
  - ▶ 1.2.5. Infra-red heating and its applications (construction and working of two appliances)

- ▶ 1.2.6. Microwave heating and its applications (construction and working of two appliances)
- ▶ 1.2.7 Solar Heating
- ▶ 1.3 Calculation of resistance heating elements (simple problems)

## **2. Electric Welding**

- ▶ 2.1 Advantages of electric welding
- ▶ 2.2 Welding methods
  - ▶ 2.2.1. Principles of resistance welding, types – spot, projection, seam and butt welding, welding equipment
  - ▶ 2.2.2 Principle of arc production, electric arc welding, characteristics of arc; carbon arc, metal arc, hydrogen arc welding method and their applications. Power supply requirement. Advantages of using coated electrodes, comparison between AC and DC arc welding, welding control circuits, welding of aluminum and copper

### **3. Electrolytic Processes:**

- ▶ 3.1 Need of electro-deposition
- ▶ 3.2 Laws of electrolysis, process of electro-deposition - clearing, operation, deposition of metals, polishing and buffing
- ▶ 3.3. Equipment and accessories for electroplating
- ▶ 3.4. Factors affecting electro-deposition
- ▶ 3.5. Principle of galvanizing and its applications
- ▶ 3.6 Principles of anodizing and its applications
- ▶ 3.7 Electroplating of non-conducting materials
- ▶ 3.8 Manufacture of chemicals by electrolytic process

### **4. Electrical Circuits used in Refrigeration, Air Conditioning and Water Coolers:**

- ▶ 4.1 Principle of air conditioning
- ▶ 4.2 Description of Electrical circuit used in
  - ▶ a) Refrigerator,
  - ▶ b) Air-conditioner, and
  - ▶ c) Water cooler

## **5. Electric Drives:**

- 5.1 Advantages of electric drives
- 5.2. Characteristics of different mechanical loads
- 5.3. Types of motors used as electric drive
- 5.4. General idea about the methods of power transfer by direct coupling by using devices like belt drive, gears, chain drives etc.
- 5.5 Examples of selection of motors for different types of domestic loads
- 5.6 Selection of drive for applications such as general workshop, textile mill, paper mill, steel mill, printing press, crane and lift etc. Application of flywheel.
- 5.7 Selection of motors for Domestic Appliances

## **6. Electric Traction:**

- 6.1 Advantages of electric traction
- 6.2 Different systems of electric traction, DC and AC systems, diesel electric system, types of services – urban, sub-urban, and main line and their speed-time curves
- 6.3 Different accessories for track electrification; such as overhead catenary wire, conductor rail system, current collector- pentagraph
- 6.4 Factors affecting scheduled speed
- 6.5. Electrical block diagram of an electric locomotive with description of various equipment and accessories used.
- 6.6 Types of motors used for electric traction
- 6.7 Power supply arrangements
- 6.8 Starting and braking of electric locomotives
- 6.9 Introduction to EMU and metro railways
- 6.10 Train Lighting Scheme

## Chapter – 1 ELECTRIC HEATING

Heat plays an important role in everyday life. All heating requirements in domestic purposes such as cooking, room heater, immersion water heaters, and electric toasters and also in industrial purposes such as welding, melting of metals, tempering, hardening, and drying can be met easily by electric heating, over the other forms of conventional heating. Heat and electricity are interchangeable. Heat also can be produced by passing the current through material to be heated. This is called electric heating. There are various methods of heating a material but electric heating is considered far superior as compared to the other heating methods such as produced by coal, oil, and natural gas.

## ADVANTAGES OF ELECTRICAL HEATING

The following are the advantages of electric heating over other the types of heating are:

1. Economical:- Electric heating equipment is cheaper, they do not require much skilled persons, therefore maintenance cost is less.
2. Cleanliness:- Since dust and ash are completely eliminated in the electric heating, it keeps surroundings clean or ash free.
3. Pollution Free:- As there are no flue gases in the electric heating, Therefore it is pollution free.
4. Ease of control:- In this heating temperature can be controlled and regulated accurately either manually or automatically as per requirement.
5. Uniform Heating:- With electric heating, the substance can be heated uniformly, throughout whether the material conducting or non-conducting.
6. High Efficiency:- In non-electric heating, only 30–60% of heat is utilized but in electric heating 80–100% of heat can be successfully utilized. Therefore, overall efficiency of electric heating is very high.

7. Automatic protection:- Protection against over current and over heating can be provided by using the automatic control devices.
8. Heating of non-conducting materials:- The heat developed in the non-conducting materials such as wood and porcelain is possible only through the electric heating.
9. Better working conditions:- No irritating noise is produced with electric heating and also radiating losses are low.
10. Less floor area:- Due to the compactness of electric furnace, floor area required is less.
11. High temperature:- High temperature can be obtained by the electric heating except the ability of the material to withstand the heat.
12. Safety:- The electric heating is quite safe.

# HEATING METHODS

Heat can be generated by passing the current through a resistance or initiation of an arc between two electrodes can also develops heat.

Electric heating can be classified as follows.

1. Resistance Heating
2. Induction Heating
3. Electric Arc Heating
4. Dielectric Heating
5. Infra-Red Heating
6. Microwave Heating
7. Solar Heating



# 1. RESISTANCE HEATING

(a) Direct resistance heating:- In this method, the electric current is made to pass through the substance to be heated. This principle of heating is employed in electrode boiler.

(b) Indirect resistance heating:- In this method, the electric current is pass through a high-resistance heating element, the heat so developed is transferred to charge which is to be heated from the heating element by convection or radiation. This method of heating is employed in immersion water heaters.

(c) Electric Oven:- Ovens are used to cook the food for domestic purpose and treatment of metals in industries. In electric oven current flows through the metallic elements to heat up the element and in turn the enclosed space and cook food.

## DIRECT RESISTANCE HEATING

In this method, electrodes are immersed in a material or charge to be heated. The charge may be in the form of powder, pieces, or liquid. The electrodes are connected to AC or DC supply as shown in Fig. In case of DC or 1- $\phi$  AC, two electrodes are immersed in the charge and connected to supply and in case of availability of 3- $\phi$  supply three electrodes are immersed in the charge. When metal or charge is to be heated, the powder of lightly resistive is sprinkled over the surface of the charge (or) pieces to avoid direct short circuit. The current flows through the charge and heat is produced in the charge itself. So, this method has high efficiency. As the current in this case is not variable, so that automatic temperature control is not possible. This method of heating is employed in salt bath furnace and electrode boiler for heating water.

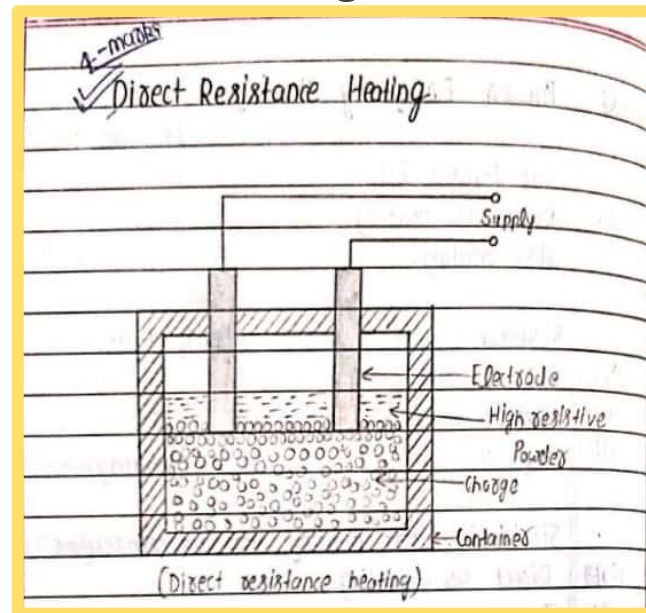

## INDIRECT RESISTANCE HEATING

In the indirect resistance heating method, high current is passed through the heating element. In case of industrial heating, sometimes the heating element is placed in a cylinder which is surrounded by the charge placed in a jacket is known as heating chamber is shown in Fig. The heat is proportional to power loss produced in the heating element is delivered to the charge by one or more of the modes of the transfer of heat viz. conduction, convection, and radiation. This arrangement provides uniform temperature and automatic temperature control. Generally, this method of heating is used in immersion water heaters, room heaters, and the resistance ovens used in domestic and commercial cooling and salt bath furnace.

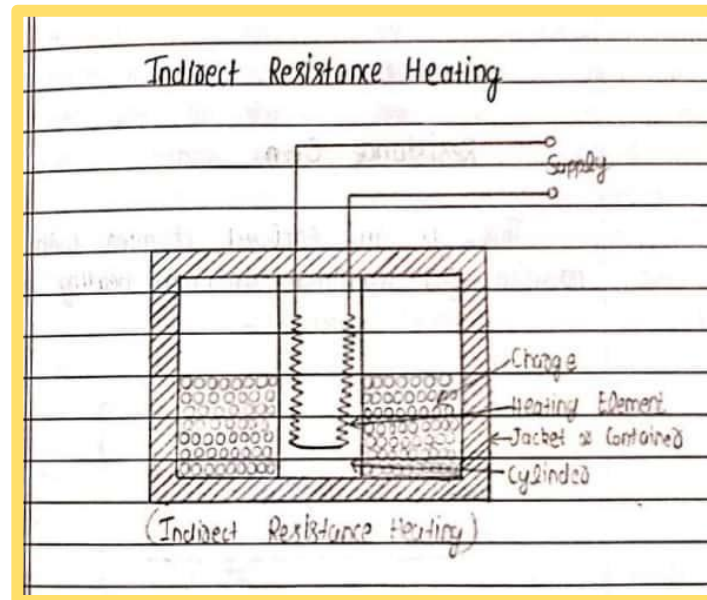

**Indirect Resistance Heating**

## ELECTRIC OVEN

Electric Ovens are appliances with enclosed space with metallic elements at the top and bottom as shown in the fig. Electric current flows through the metallic elements to heat up the element and in turn the enclosed space and cook food. The thermostat in the oven (if there is one) measures the temperature and adjusts the current through the element to maintain the temperature. Additionally, some ovens (convection) also have fans that uniformly distribute the heat. These ovens with fans are much more efficient than conventional ovens as they uniformly distribute the heat and thus can help in reducing the thermostat temperature.

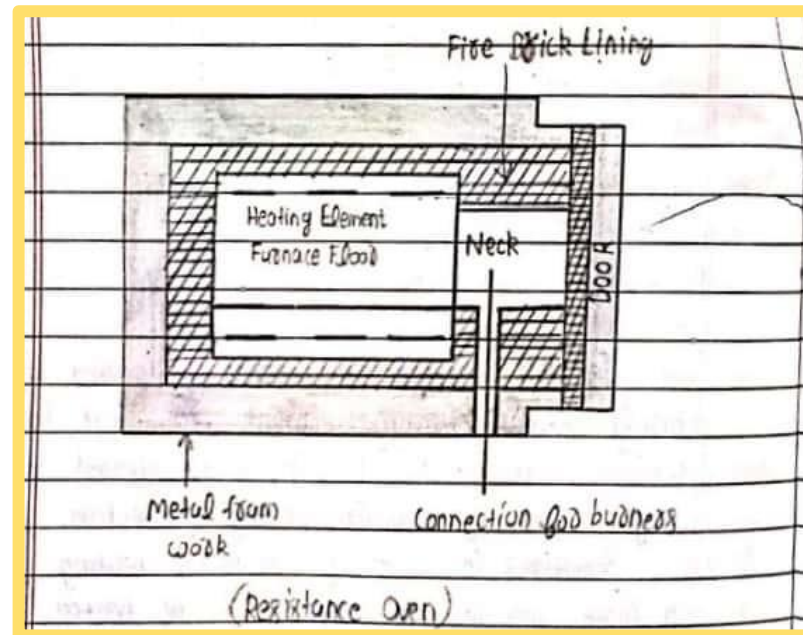

Electric Oven

## TEMPERATURE RANGE

S. No.	Property	Nickel Chromium	Nickel Chromium Iron	Nickel Copper	Iron Chromium Aluminum
1.	Maximum temperature of operation	1100°C	950°C	400°C	1100 to 1300°C
2.	Specific gravity	8.36	8.28	8.88	7.2
3.	Composition	80% Ni 20% Cr	60%Ni 24%Fe 16%Cr	45% Ni 55% Cu	30%Cr 5%Al 65%Fe
4.	Melting Pt	1375°C	1400°C	700°C	1450°C

# PROPERTIES OF RESISTANCE HEATING ELEMENTS

1. High Resistance:- Material should have high-specific resistance so that small length of wire may be required to provide given amount of heat.
2. High Melting Point:- It should have high-melting point so that it can withstand for high temperature, a small increase in temperature will not destroy the element.
3. Low Temperature Coefficient of Resistance:- From Equation (4.1), the radiant heat is proportional to fourth powers of the temperatures, it is very efficient heating at high temperature. For accurate temperature control, the variation of resistance with the operating temperature should be very low. This can be obtained only if the material has low temperature coefficient of resistance
4. Free from Oxidation:- The element material should not be oxidized when it is subjected to high temperatures otherwise the formation of oxidized layers will shorten its life.
5. High Mechanical Strength:- The material should have high-mechanical strength and should withstand for mechanical vibrations.
6. Non Corrosive:- The element should not corrode when exposed to atmosphere or any other chemical fumes.

# HEATING APPLICATION

## Domestic Application Of Electrical Fitting

1. Room Heater
2. Immersion Rod for water heating
3. Hot Plate for cooking
4. Electric Geyser
5. Electric kettle
6. Electric Iron
7. Electric Oven for baking products
8. Electric Toaster

## Industrial Application Of Electric Heating

1. Melting of metals
2. Electric welding
3. Moulding of Glass for making glass appliances
4. Making of insulator
5. Moulding of plastic component
6. Heat treatment
7. Making of plywood

## THERMOSTAT CONTROL CIRCUIT:-

A thermostat is a thermal switch. Basically it is a bimetallic strip. This is used in the automatic heating appliances to control the temperature. It is connected in series with the resistance element.

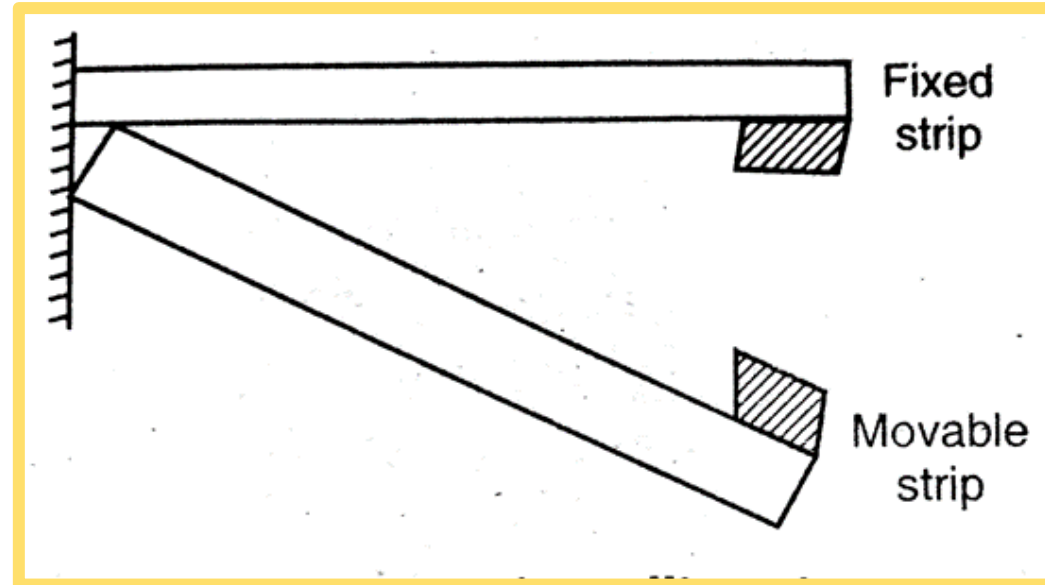

A bimetallic strip consists of two strips of different metals, having a different coefficient of expansions, securely fastened together. When the thermostat is connected in series with the resistance element and current starts flowing through the thermostat, bimetallic strip starts bending.



## 2. INDUCTION HEATING

We know when a coil is wound on a magnetic Core and is given supply then magnetic field is produced. If this field changes its magnitude, an EMF is produced and if circuit is closed then current will flows. Transformer is an example of low frequency induction heating. If ac current flow through the coil wound on a core, the magnetic flux linking with the core changes hence an EMF induced in the core. As core provides a closed path, eddy current starts flowing through the core. Now if the substance to be heated is used as core then the substance can be heated by flowing this eddy current. This is the principle of induction heating/furnaces.

Induction heating are of following two types

1. Core Type Induction Furnace
  - (a) Direct Core Type
  - (b) Vertical Core Type
2. Coreless Type Induction Furnace

## (a) Core type induction furnace or Horizontal core type induction furnace:-

The core type induction furnace is just like a transformer having primary winding and connect to the supply. The charge is to be heated on secondary side.

In this fig. consists of an iron core, cu primary winding connected to an AC supply. The furnace consists of a circular hearth in the form of a trough, which contains the charge to be melted in the form of an annular ring. When there is no molten metal in the hearth, the secondary becomes open circuited secondary current flows. Hence, to start the furnace, the molten metal has to be taken in the hearth to keep the secondary as short circuit. The charge is kept in the crucible which forms a single term short circuited secondary circuit. The current in the charge is very high of the order of several thousand amperes which heats it. Another disadvantage is that it requires a low frequency (10 Hz to 25 Hz) supply, which requires a frequency changer, which makes it costly.

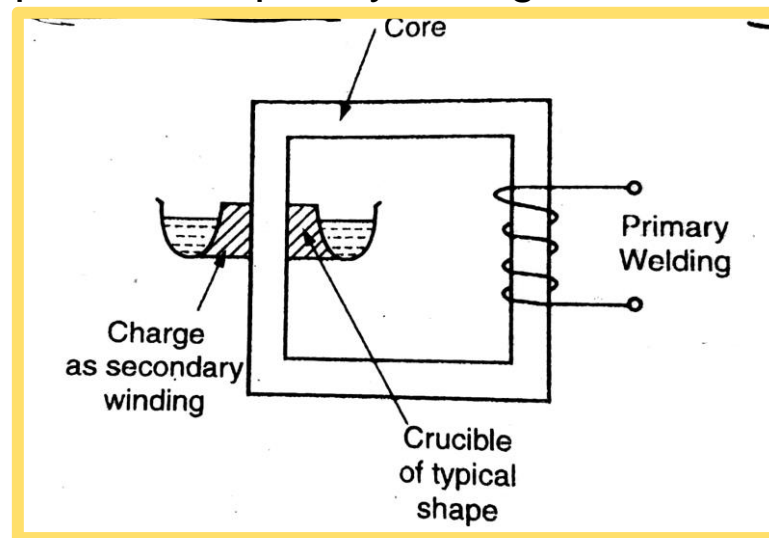

## (b) Vertical Core type induction furnace:-

This is a much-improved version of the above core type induction furnace and it's designed to use a vertical channel instead of horizontal core for the charge. So that the crucible used is also vertical which is convenient from metallurgical point of view. In this furnace magnetic coupling is comparatively better and power factor is high hence it can be operated from normal frequency supply i.e. 50Hz. The circulation of molten metal is kept up around the V portion of by convection current as shown in fig. As V channel is narrow even a small quantity of charge is sufficient to keep the secondary circuit closed. However V Channel must be kept full of charge in order to maintain continuity of secondary circuit. The material for inner lining of the furnace depends on the type of charge used, clay lining is used for Yellow brass. The top of the furnace is covered with an insulator cover. The charge is put into the furnace from the top and the molten metal is taken out through the spout.

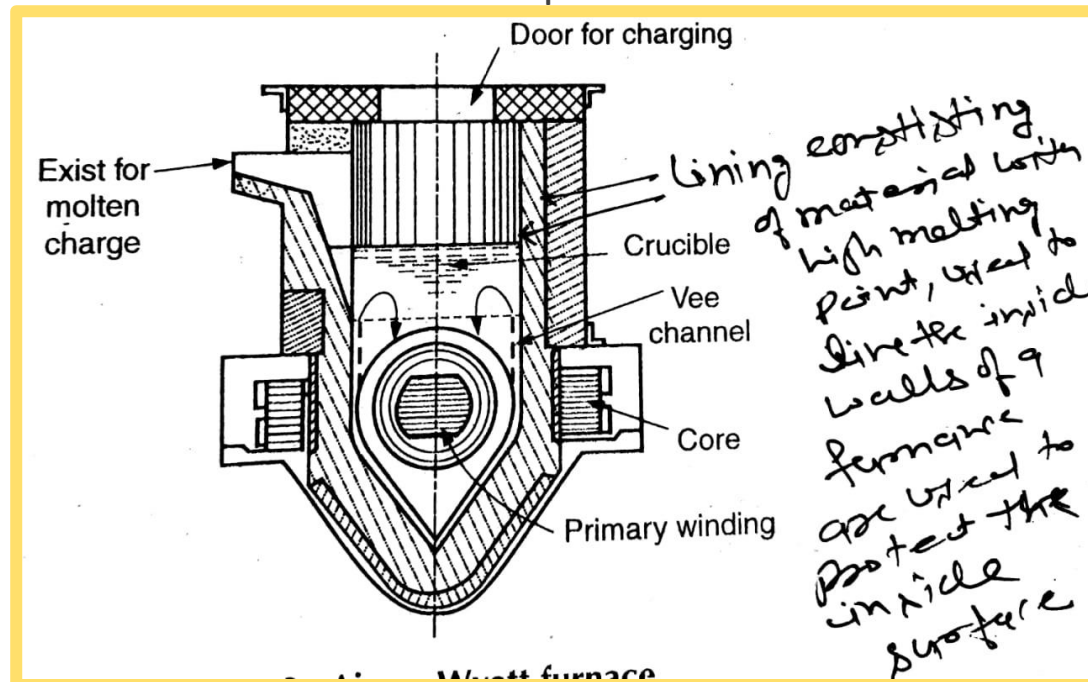

## (2) CORELESS TYPE INDUCTION FURNACE:-

Coreless type induction furnace is a simple furnace with the absence core as shown in fig. In this furnace, heat produced in the charge due to eddy currents flowing through it. The coreless induction furnace unit consisting of a primary helically wound coil surrounding a refractory crucible containing the molten charge and the frame. The charge is put into the crucible and primary winding is connected to a high frequency AC supply. The flux produced by the primary section setup the eddy current in charge and heat it up to the melting point. The charge need not be in the molten state at the start as was required by the horizontal core type furnace.

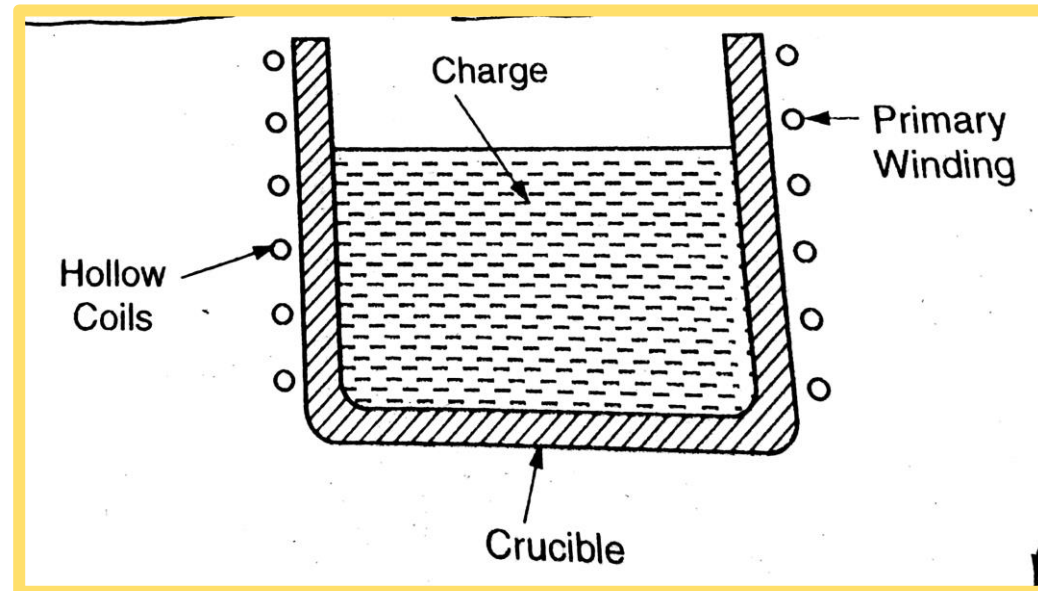

The applications of these furnaces include vacuum melting in a controlled atmosphere where high frequency is required. It is also used in electronic industries such as sterilizing surgical instruments.

### (3) Electric Arc Heating:-

Heat is produced with the help of electric arc by using Electric arc furnace. Electric Arc Furnace means an extremely hot enclosed chamber, where heat is produced by means of electrical supply provided to the Carbon/Graphite electrodes for melting certain metals such as scrap steel without changing the properties of the scrap metal. Electric arc is produced between the electrodes if a sufficiently high voltage is applied across an air gap between electrodes, the air becomes ionized and start conducting in the form of arc and produced heat. The electric arc heating furnace are of following two types.

1. Direct Arc Furnace
2. Indirect Arc Furnace

# (1) Direct Arc Furnace:-

The direct arc furnace is lined with basic or acidic lining. In single phase two electrodes enter from the top of the combustion chamber of arc furnace. As shown in fig. electrodes are connected to the electric supply and current is passed through the charge and arc is struck between the charge and the electrodes because the air becomes ionized and start conducting in the form of arc and produced heat. Enormous heat and a very high temperature is produced These furnaces are available from 10 to 100 tons capacity.

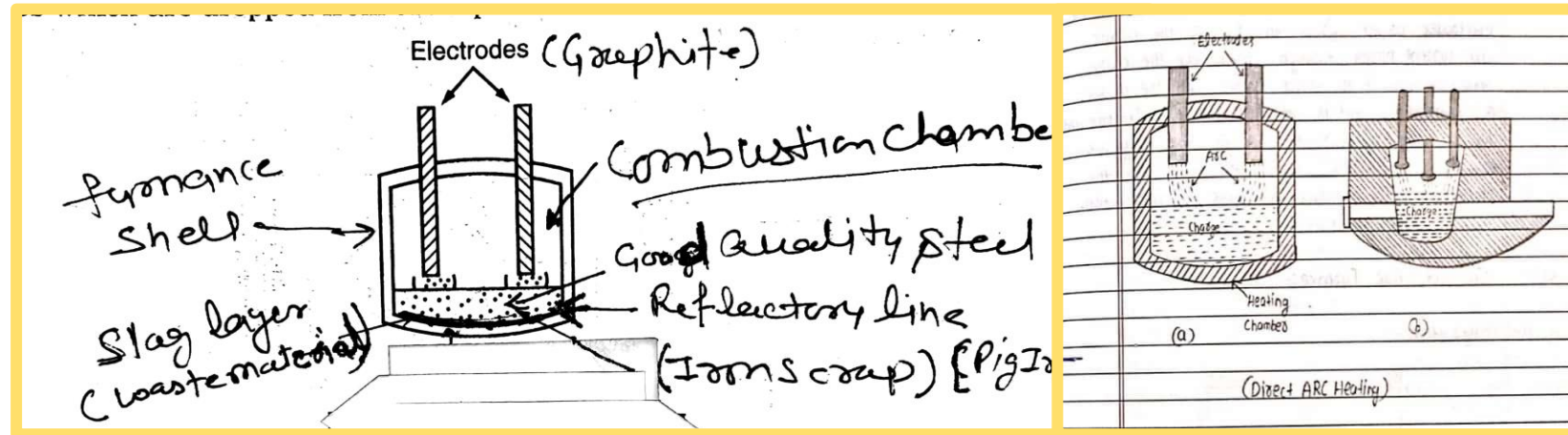

(1-Phase direct Arc Furnace)

In three phase direct arc furnace 3 electrodes are used. The electrodes are totally dipped into the charge and heat is produced by the resistance of the charge offered in the path of flow of current. The charge forms the star point.

### 3-PHASE DIRECT ARC FURNACE

As current flows through the charge, stirring action is also produced in the charge and as a result a very uniform output is obtained. The quality of the output is purer than that obtained from couple furnace. It is to be noted that melting in couple and refining in arc furnace has proved to be economical. The 3 phase direct arc furnace shown in the Fig. 2.22 has a steel bowl chamber with refractory lining. The furnace is mounted in tilting or rocking mechanism to pour out molten metal.

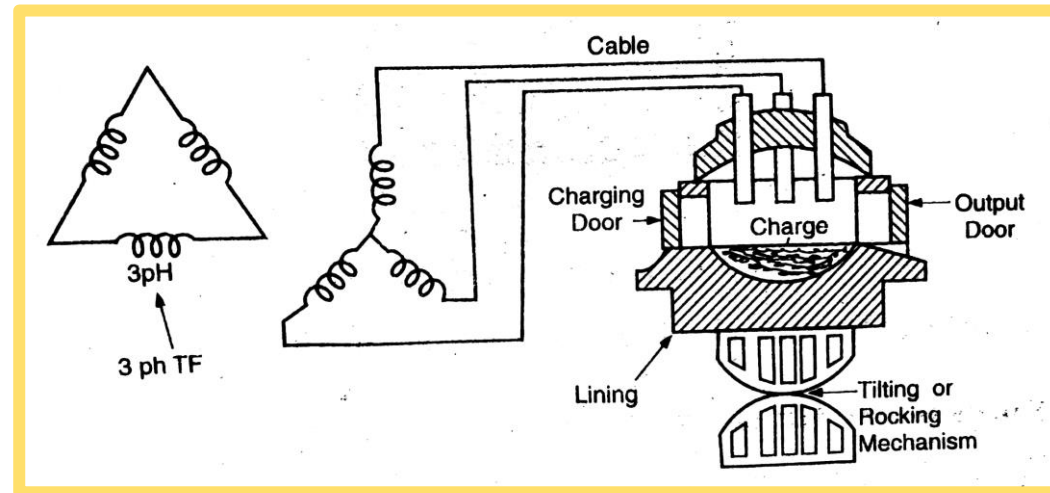

(3-Phase direct Arc Furnace)

The direct arc furnaces are widely used in the steel industry for refining and making alloy steels and for melting non - ferrous alloys. For a one ton furnace, about 200 KW power is required. About 1000KWh per ton energy is consumed for melting steel.

## (2) INDIRECT ARC FURNACE:-

In this type of furnace current does not pass through the charge but through the electrodes by radiation, that is why this is called an indirect arc furnace. Below fig. shows the Indirect arc furnace. As current does not pass through the charge, no stirring action takes place through the charge. Since heat is transferred to the charge by radiation, the temperature of charge in this type of furnace is lower than that of the charge in the direct arc furnace. The furnace is to be rocked mechanically for proper heating of the charge. For this reason a cylindrical shape is given to the furnace. In this type of furnace only two electrodes can be used. Therefore, this furnace cannot be used on 3 phase supply. The melting of non-ferrous alloys is the main field of application of these furnaces. The electrodes are to be replaced after some time as they are consumed due to oxidation.

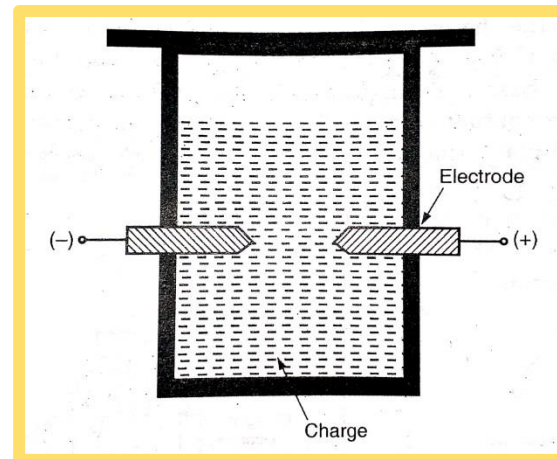

Application of Electric arc furnace :- This furnace is used for melting non ferrous metals like brass, zinc, tin, bronze, copper etc.



## (4) DIELECTRIC HEATING:-

Dielectric heating is similar to the structure of the capacitor. In a capacitor, dielectric material is placed between two conducting plates and electricity is produced in a dielectric. Whereas in a dielectric heating system, the material to be heated is placed between two conducting plates. When an electric field is applied to the conducting plates, heat is generated inside the material.

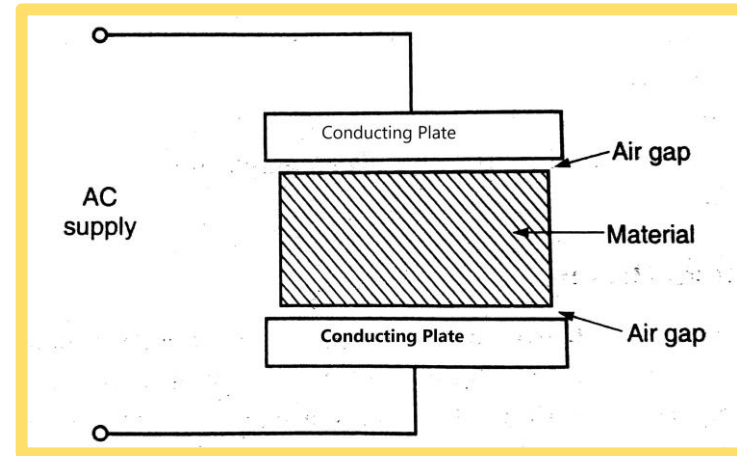

The dielectric heating is also known as H.F. capacitor heating. It is used for non-metal and dielectric materials like wood, cloth, paper, plastic, etc. The frequency applied is in MHz and voltage near 20 KV. Heating takes place in the material itself. The heating takes place in lesser time than the heating in furnaces. There is no other method for heating the insulating materials.

When a capacitor is subjected to sinusoidal voltage, current leads the voltage by  $90^\circ$  but practically this angle is less and hence dielectric loss occurs. At small frequencies this loss is less but at MHz frequencies this loss is enough to heat the material. The insulating material to be heated is kept between two conducting plates across which H.F. voltage is applied. This forms a capacitor and the dielectric losses occur in the insulating material which heated up the material.

## APPLICATION OF DIELECTRIC HEATING

The applications of the dielectric heating as under:

1. It is used to drying of paper, wood, etc.
2. It is used for gluing of wood for making panels. It takes very less time as compared to other heating process.
3. It is used to heat up the raw plastic.
4. It is used to for processing in chocolate industry.
5. It is used in food processing such as dehydrating milk, cream, and vegetables.
6. It is used to preparation of thermoplastic resins.
7. It is used for evaporating purpose.
8. It is used for drying process in textile industry.

## (5) INFRA-RED HEATING:-

In this method of heating, the heat energy is transferred from source (incandescent lamp) and focused upon the body to be heated up in the form of electromagnetic radiations. Normally, this method is used for drying clothes in the textile industry and to dry the wet paints on an object. This is also called as Radiant heating. In this heating element is made of tungsten which also operates at  $2500^{\circ}\text{C}$  and at this temperature, the element emits sufficient infra red (IR) radiations. This temperature is higher than the resistance heating. The heating effect on the charge is greater. The heat emission efficiency may be up to 7200 Watt per m<sup>2</sup> which leads to heat absorption up to 4000 watt per m<sup>2</sup>. This reduces time for various drying processes. This method is used for drying of paints, foundry molds and heating plastics etc.

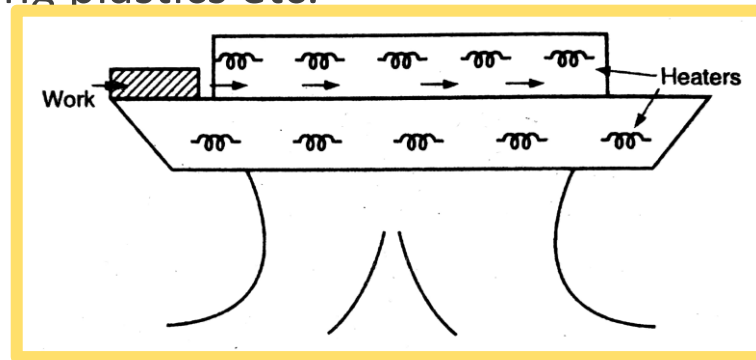

The machine is useful for large scale production. The heaters are installed on the upper and lower areas to provide uniform heating. The simplified view of infrared furnace has been shown in Fig. The infrared sources are Quartz lamps whose range of temperature is  $400^{\circ}\text{C}$  -  $1000^{\circ}\text{C}$ . The machine is divided into different heating zones (called preheating and reflow zones)

## APPLICATION OF INFRARED HEATING:-

1. Infrared Heating is used for food processing.
2. Infrared Heating is used for Baking - manufacture of Bread etc.
3. Infrared Heating is used for Drying of paper and textiles.
4. Infrared is used for treatment of cancer and other diseases.
5. Infrared Heating is used for Manufacture of plastics.
6. Infrared Heating is used for processing of timber, cement etc.

## (6) MICROWAVE HEATING AND APPLICATION:-

In RF Heating or Microwave Heating the material is subjected to an electromagnetic wave that causes the molecules in the material to oscillate, thereby generating heat. This phenomenon has applications ranging from microwave ovens, through therapeutic medical treatment, to material processing in the manufacturing industry. Microwave heating, uses electromagnetic energy in the frequency range 300-3000 MHz and is used to heat many dielectric materials. Microwave heating is used industrial, scientific and medical applications, for frequencies between 915 and 2450 MHz. Domestic microwave ovens uses a frequency of at 2450 MHz. The way in which a material will be heated by microwaves depends on its

(a) Shape (b) Size (c) Dielectric constant and (d) Nature of the microwave equipment used.

Although microwave radiation is best known for heating food in the kitchen, in recent years it has found new application in many industrial process such as those involving melting, smelting, drying and joining. Heating by microwave radiation constitutes highly coupled nonlinear problem giving rise to new and unexpected physical behavior the best know of which is the appearance of “hot spots”. That is in many industrial applications of microwave heating it has been observed that heating does not take place uniformly but rather regions of very high temperature tend to form.

## (7) SOLAR HEATING:-

Solar heating is the most readily available source of energy. It does not belong to anyone and therefore, it is free. It is also the most important of the non-conventional sources of energy because it is non-polluting and therefore, helps in lessening the greenhouse effect

- Heat from the sun in the form of radiation passes through the atmosphere where most of it is absorbed by the Earth.
- Some infrared radiation (heat) is reflected back into space.
- Greenhouse gases act as heat trap also known as atmosphere glass, trapping some of this infrared radiation (heat) return back to the earth to forms more heat on earth's surface.
- Without greenhouse gases or glass, the average temperature on Earth would be  $60^{\circ}\text{F}$  and life on Earth would look very different than it does today.
- Just like greenhouse effect we use heat collector to collect heat which comes sun.
- Solar heat is used for many purpose like solar water heater, solar furnace, solar cooker etc.

# Solar Water Heating

Solar Water Heating: A solar water heating unit consists of a blackened flat plate metal collector with an associated metal tubing facing the general direction of the sun. The plate collector has a transparent glass cover above and a layer of thermal insulation beneath it. The metal tubing of the collector is connected by a pipe to an insulated tank that stores hot water during cloudy days. The collector absorbs solar radiations and transfers the heat to the water circulating through the tubing either by gravity or by a pump. This hot water is supplied to the storage tank via the associated metal tubing. This system of water heating is commonly used in hotels, guest houses, tourist bungalows, hospitals, canteens as well as domestic and industrial units.

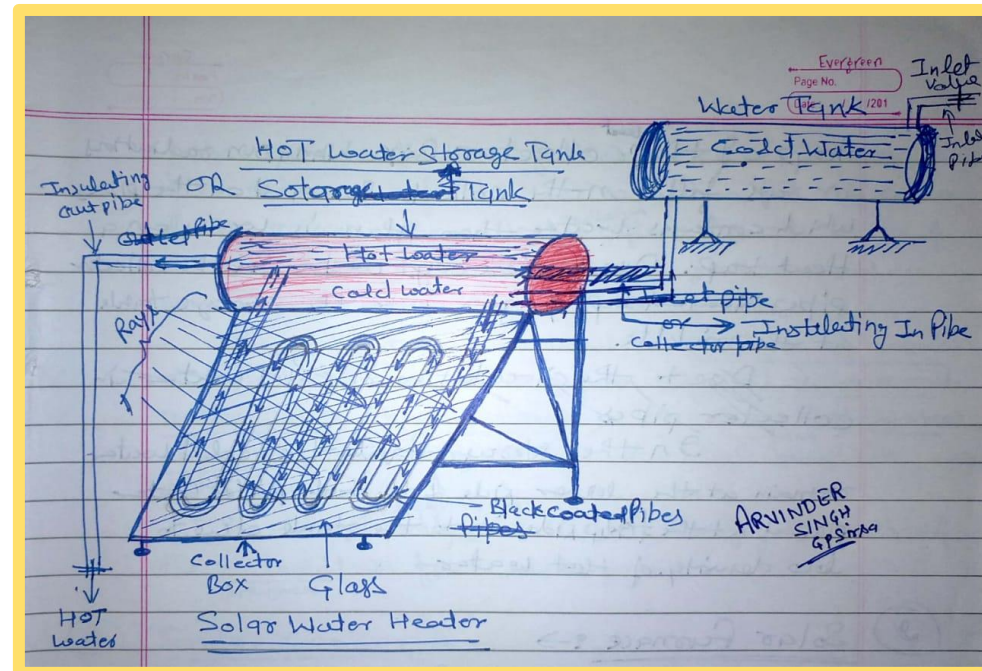

## CHAPTER – 2 ELECTRIC WELDING

Electric welding of is the process of joining metals of two similar composition by heating them to a suitable temperature with or without the application of pressure and addition of filler material.

### Advantages Of Electric Welding :-

1. It can join all commercial metals.
2. It can be used anywhere.
3. It provides better utilization of material.
4. It is flexible.
5. Welding is the lowest cost joining method.
6. Its weight is less.
7. Its can provide leak proof joint.
8. It can join two or more pieces of metal to make them act as one piece.



## Electric Welding Methods:-

Electric welding is defined as that branch of welding in which electric current is used to produce the large amount of heat required for joining together two pieces of metal the two important methods of welding are below.

1. Resistance welding
2. Arc welding

1. Resistance welding:- Resistance welding is that process in which heavy current is made to pass through the joint to be welded. This heavy current generates enough heat this heat due to  $I^2R$  losses that melt the metal and cause fusion at the point of contact. Resistance welding includes butt welding, spot welding, projection welding and seam welding.

Butt welding:- In butt welding, the two parts to be welded are held in clamps, one of which is fixed and the other is movable. The ends of the two parts to be welded are brought together and pressure is applied along the axial direction by a spring. A heavy current is made to pass from the welding transformer which generates the required heat at the joint due to resistance of the contact area. Due to the pressure applied by the spring the molten metal is forced out, thus producing butt joint as shown in figure

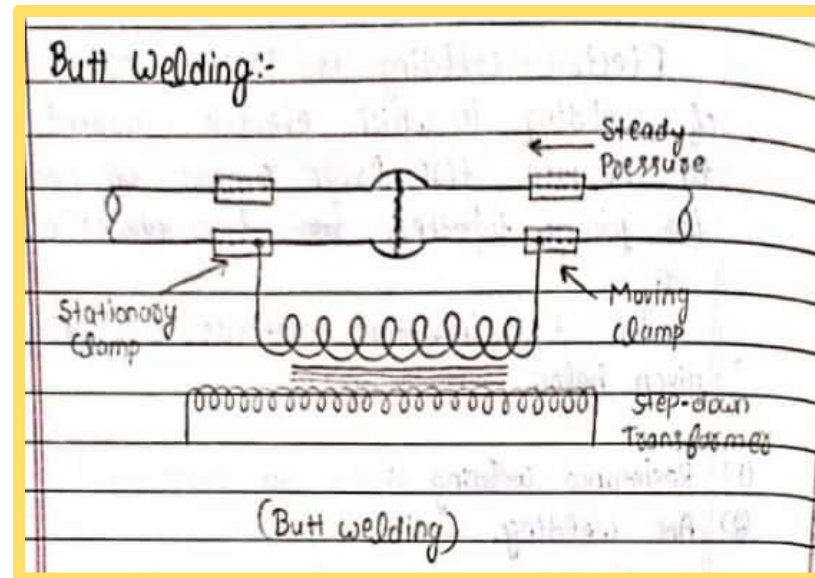

## SPOT WELDING :-

This is the simplest and universally adopted method of making lap welds in thin sheets up to a maximum thickness of 12.7mm . The Sheets to be welded are held over lapping between the two electrodes. One movable and the other is fixed. Heavy current is passed through the electrodes. Adequate pressure is applied at the Spot where joint is to be produced However, the pressure of the electrodes reduces the surface contact resistance over the position under welding them and hence, most of the current passes.

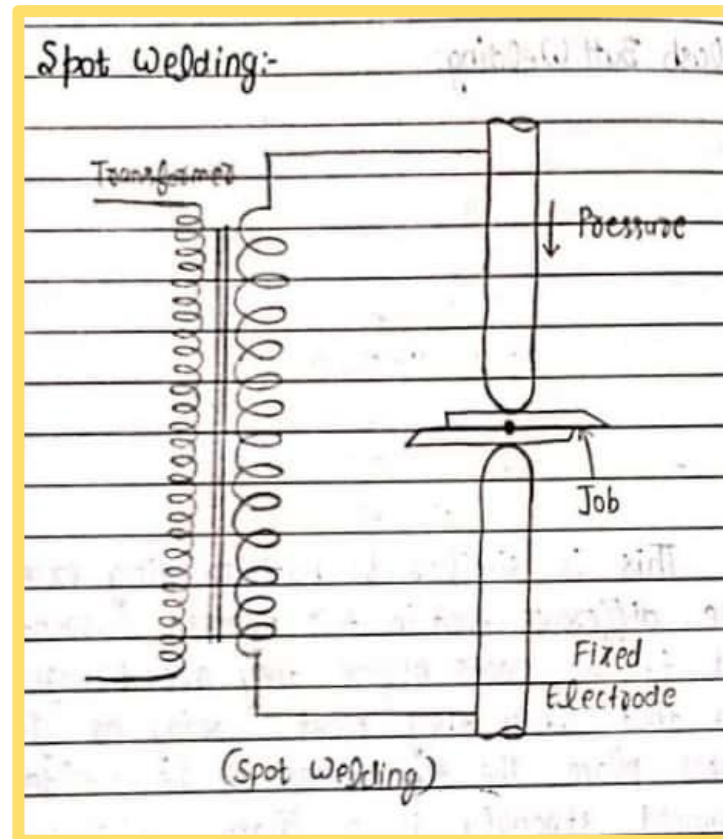

**PROJECTION WELDING** :- It is a modified form of spot welding. The only difference is that the electrodes used are flat on the end and larger in diameter. It has T-slotted platens. When the upper plate is lowered on the work pieces Supported on the lower platen, an electric circuit is completed and the weld current starts flowing. This heavy current heats and fuses the two plates together. This process of welding requires much less pressure to bring the workpiece into contact. The time taken to this welding is very short as compared to other types of resistance welding.

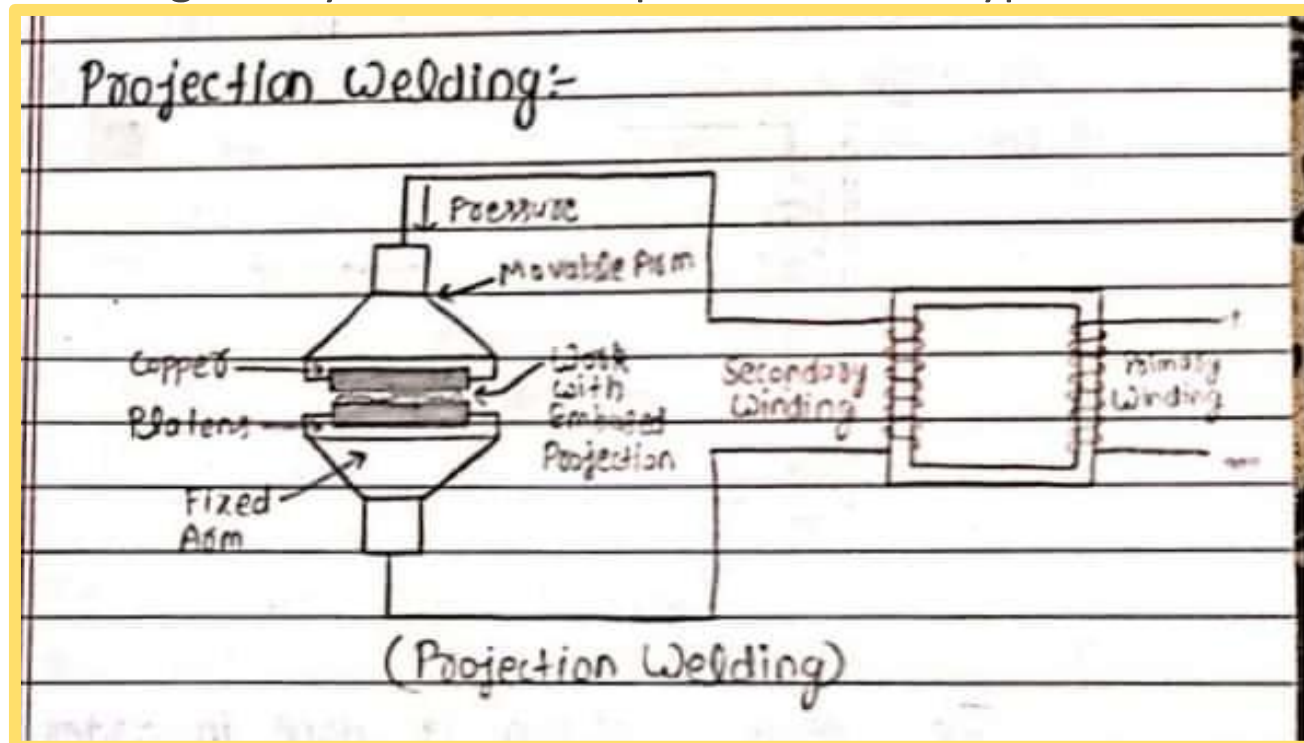

## SEAM WELDING :-

The seam welding is done in order to produce continuous joints which may be required for the construction of tanks and cylindrical pieces. The mechanical pressure is kept constant. The current is passed through the electrodes intermittently i.e. it flows for short period and remains off for the next time interval of time and so on.

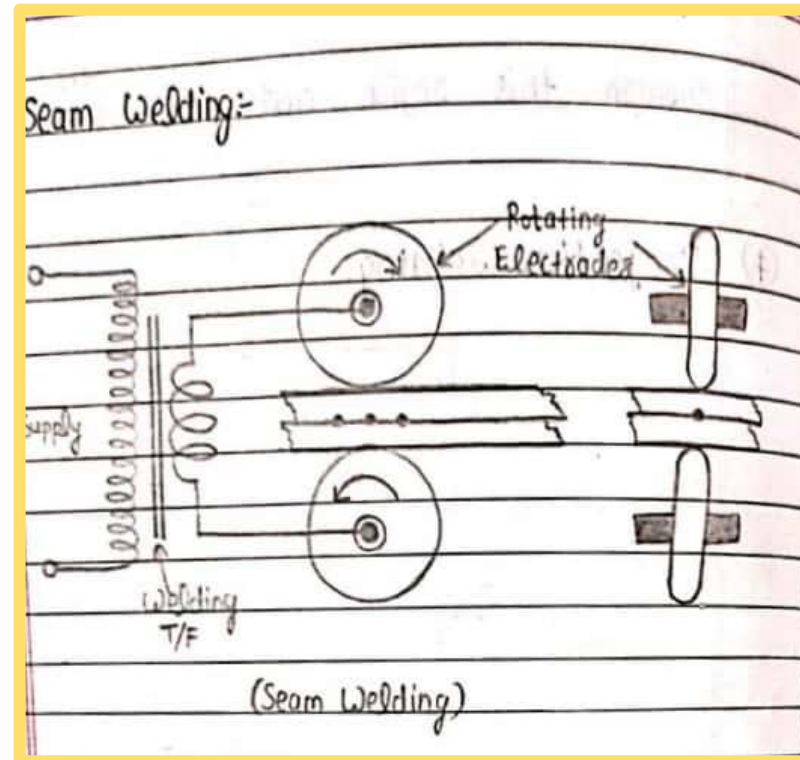

## 2. PRINCIPLE OF ARC PRODUCTION :-

An electric arc is the flow of current through gases with bright glow. An electric Arc can be produced by short circulating the two electrodes. Electric arc welding is a process in which an electric arc is produced by bringing the two conductor or electrode and workpiece connected to a suitable sources of supply in contact with each other and then separating by a small distance. The current remains flowing across the small air gap and gives intense heat. The Heat developed by the arc is utilized to melt the part of the workpiece and the filler material thus forming a joint. The heat developed by the arc may be used for cutting of metals.

The temperature of the Earth is about  $3600^{\circ}\text{C}$  which is adequate for melting and welding of normally used metals.

# ELECTRIC ARC WELDING

The types of electric arc welding is as follows.

- ▶ 1 Carbon arc welding.
- ▶ 2 Metal arc welding
- ▶ 3 Hydrogen arc welding
- ▶ 4 Gas Shield arc welding

# Characteristics of Arc

Characteristics of Arc:- The Arc has negative resistance characteristic that is the resistance of the arc decreases with increase of temperature. The decrease resistance will further increase the current. Due to this characteristic it is not possible to maintain a steady arc. To overcome this difficulty the supply to the earth should be such that the voltage falls rapidly with increase in current. In other words the source of supply should have a dropping characteristic.

To obtain a steady arc in Dc and AC welding, steady arc can be obtained.

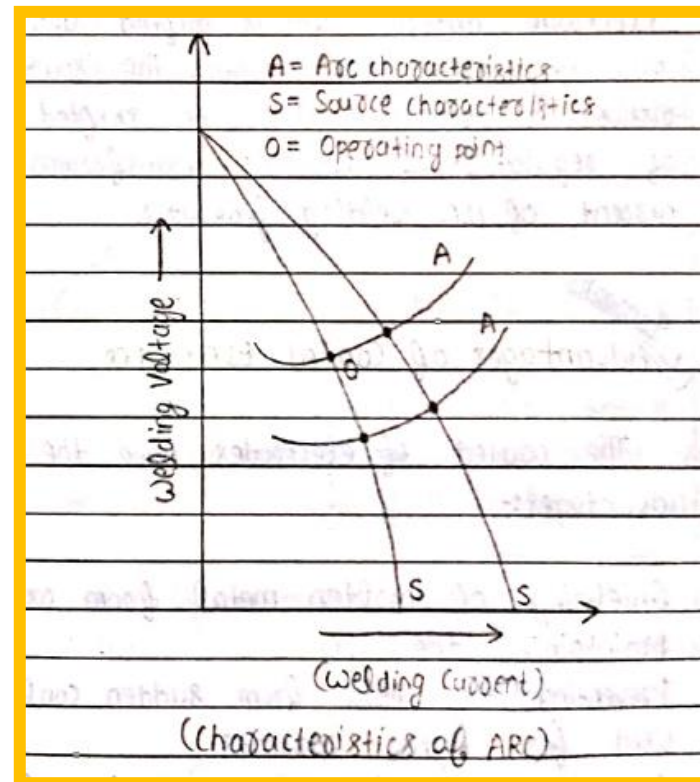



## Carbon arc welding.

Carbon arc welding, in this type of welding an arc is struck between the carbon electrode and the workpiece to be joined. When additional material is required as filler rod is used as shown in figure.

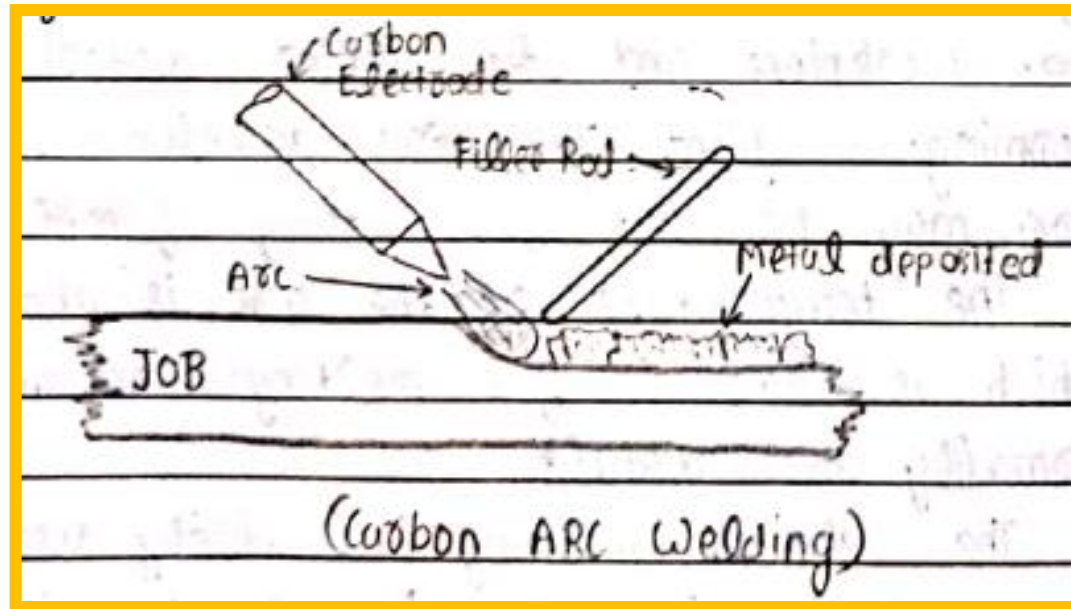

## METAL ARC WELDING

In metal arc welding a metal rod of same material is used as an electrode. The same electrode is also used as filler material . For metal arc welding A.C or D.C can be used. Electric supply is connected between electrode and work piece. After connecting supply the work piece is touched by the electrode and then separated, results in an arc between the job and the electrode produced. A little portion of the work and the tip of the electrode melts due to the heat generated by the arc. When the metal cools down then giving a strong welded joint.

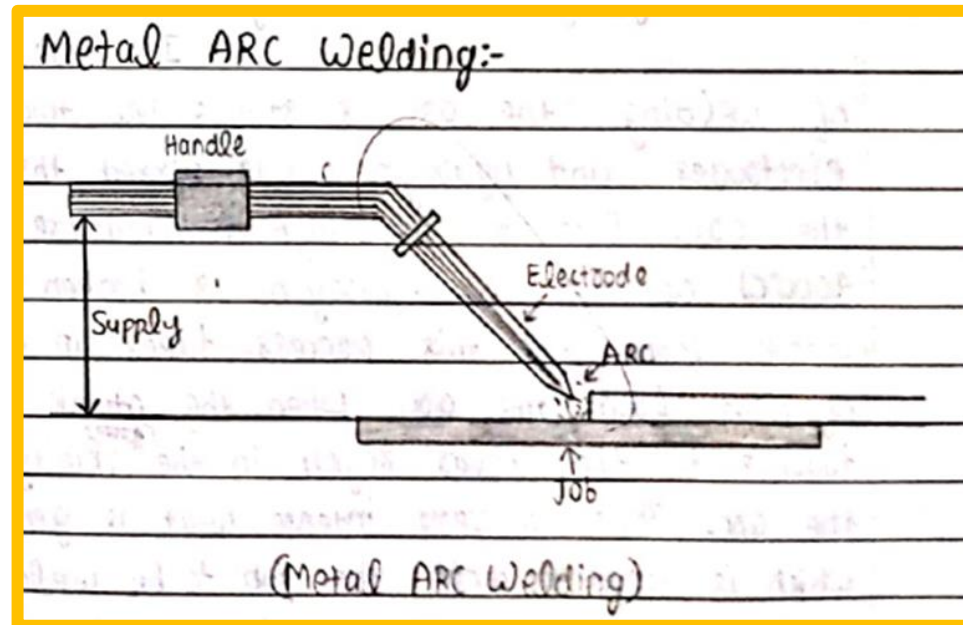

## HYDROGEN ARC WELDING

In this type of welding the arc is struck between the two tungsten electrode and hydrogen gas is passed through the arc. A process in which the welding heat is generated by passing a stream of hydrogen through an electric arc between two tungsten electrodes. Due to the high temperature about  $4000^{\circ}\text{C}$  of arc and hydrogen atoms break down. When the hydrogen strikes to a cold surface, it recombines into its diatomic form releasing the energy associated with the formation of that bond.

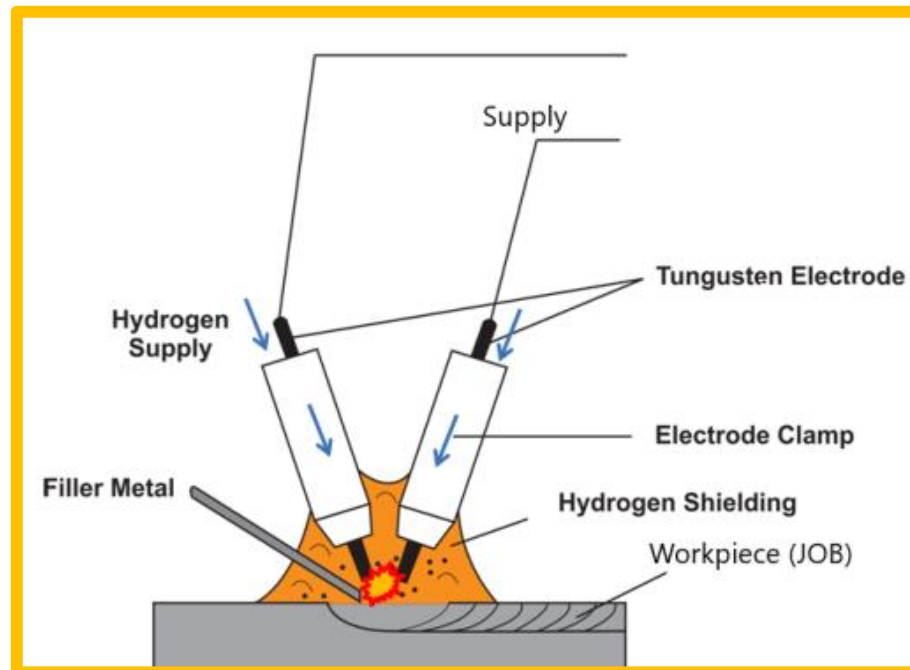

## Advantages of Coated Electrodes:-

The coated electrodes have the following advantages:

- (1) Shielding of molten metal from oxidization.
- (2) Maintaining the arc
- (3) Preventing the weld from Sudden cooling.
- (4) Used for higher currents.
- (5) Prevention of spattering of Metals

## Power supply for Arc Welding:-

Both dc and ac are used for electric arc welding. The basic requirement is that the source of voltage should have high open circuit. voltage to enable the striking of an arc. The voltage required to strike the arc is 50-60 volt in case of DC supply and about 100 volt in case of AC. To maintain the arc a voltage of 20-30 volt is required.

# Comparison between AC and DC Arc welding

## A.C. Welding

1. The equipment required is cheap.
2. High efficiency because transformer is used.
3. Low running cost.
4. Non uniform heating.
5. Only cathode electrode used.
6. Arc is never stable.
7. Less wear and tear because no rotating part.
8. Danger of getting shock due to high open circuit voltage.

## D.C. Welding

1. The equipment required is costly.
2. Low efficiency because two machines (Motor and Generator) are used.
3. High running cost.
4. Uniform heating.
5. Any type of electrode can use.
6. Arc is more stable.
7. More wear & tear because motor generator is a rotating devices.
8. No danger of getting shock due to low open circuit voltage

## WELDING CONTROL CIRCUIT:-

In modern equipment, the current is passed for a fraction of seconds. The equipment accordingly is of the following types

1. Time controlled
2. Current controlled
3. Energy controlled

1. Time controlled equipment :- This is used for high speed work and where the work has a clean surface. The time is controlled through vacuum triodes, thyratrons or Ignitrons tubes.

2. Current controlled equipment :- This type of equipment is not in use, because these are not reliable and successful.

## WELDING CONTROL CIRCUIT:-

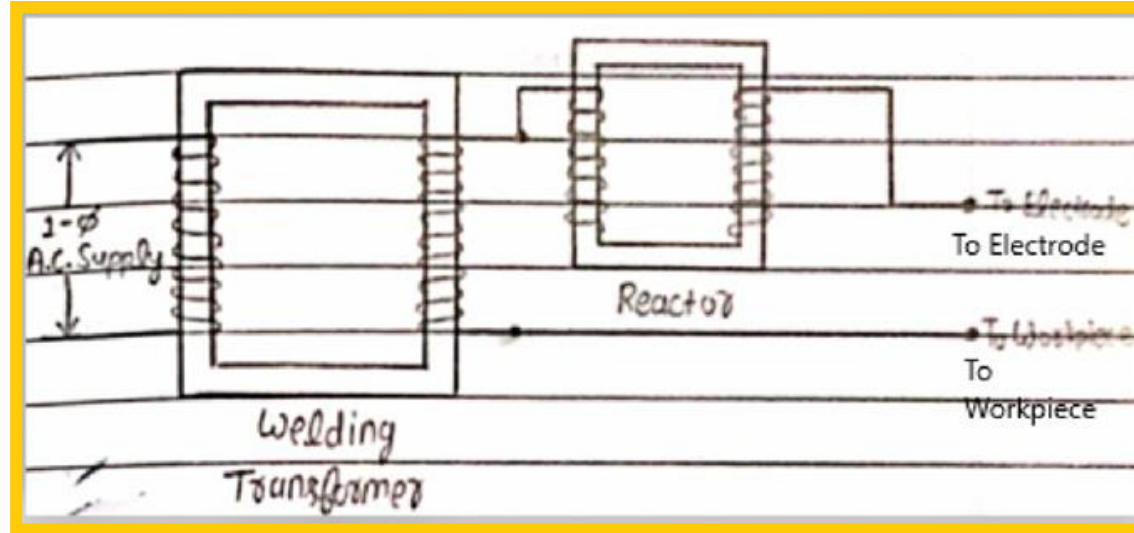

3. Energy controlled equipment :- In this, a controlled amount of energy is fed to the weld. This method is also not popular due to complicated equipment. A circuit for the above using Ignitron tubes are given. This arrangement keeps the current wave nearly sinusoidal and also reduces its magnitude.

# WELDING OF ALUMINUM AND COPPER

## MIG metal inert gas welding :-

It is a type of arc welding in which the welded material is protected from the access of the air by shield of inert gas such as  $\text{CO}_2$  oxygen and helium. profile for gas sensitive materials such as CU ,Al, protective oxygen or Helium are used for shielding MIG welding is particularly suitable for aluminum welding.

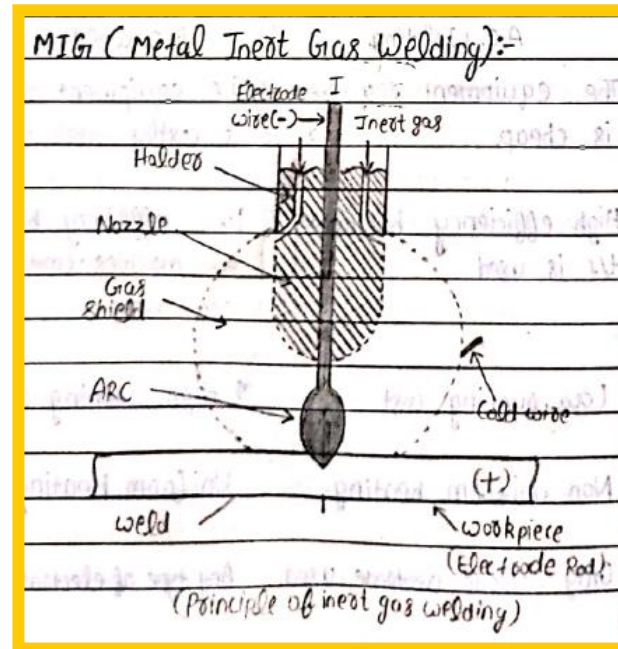



## WELDING OF ALUMINUM AND COPPER

### TIG welding tungsten inert gas welding and plasma process :-

This is a type of arc welding in which tungsten electrodes are used without adding other material. Inert gas such as nitrogen is used for shielding. Plasma welding is a modification of tig welding in which the inert gas is so directed that a Plasma in a side gas Jet was a managing.

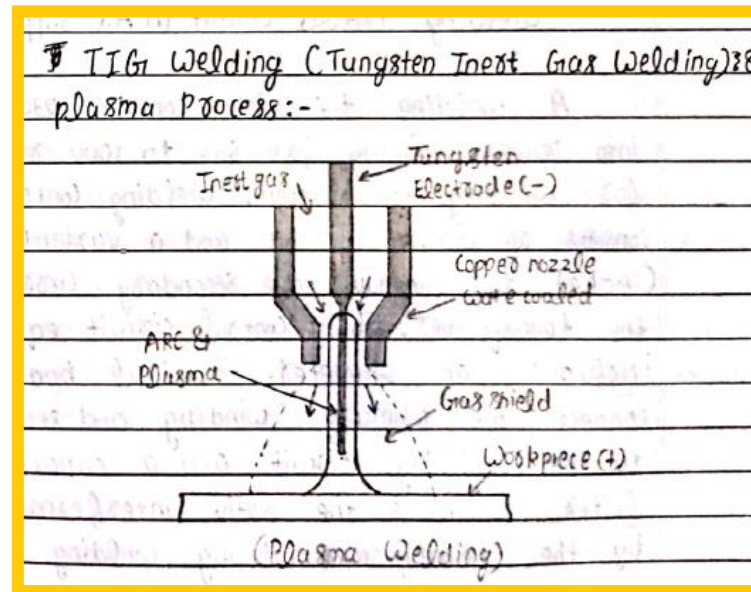

# CHAPTER –3 Electrolytic Processes

## NEED OF ELECTRO-DEPOSITION

This is defined as the process of covering the articles made up of inferior metal by a thin coating of superior metal such as iron with nickel, chromium, silver or gold. Electroplating is needed with one or more of the following requirements.

- (1) Protection of metallic surface against corrosion.
- (2) Giving shiny appearance to the articles.
- (3) Providing reflecting properties to reflectors.
- (4) Replacing the worn out material.

# FARADAY'S LAWS OF ELECTROLYSIS

(1) **Faraday's First Law:-** It states, during electrolysis process , the amount of chemical reaction take place at electrode under the influence of electrical energy is proportional to the quantity of electricity passed through the electrolyte.

i.e.  $M \propto Q \times I.T$

Where “m” is the weight of substance liberated, T is the steady current flowing through the electrolyte and T is time of current flow in seconds.

$$M \propto I.T$$

or  $M = Z.I.T$

Where Z is constant and is called Electrochemical Equivalent (E.C.E.)

It is expressed in milligram/coulomb.

## (2) Faraday's Second Law:-

When the same quantity of electricity is passed through different electrolytic the weights of the substances liberated from each will be proportional to their chemical equivalent or equivalent weights.

**Chemical Equivalent**= Atomic Weight / Valency

Since, atomic weight of hydrogen is unity and so also its valency. Therefore, its chemical equivalent is 1.

# Process of Electro-Deposition

The solution of a salt when used for electrolytic process is called on electrolyte. If two electrodes are dipped into the electrolyte and potential difference is applied across the electrodes the electrode connect to the positive terminal of the supply is known as anode and the other connected to the negative terminal of the supply is called cathode. In the electrolyte, the molecules of the salt dissociate into two ions. one of which are positively charged called and the other are negatively charged called ions. As we known that opposite charges attract each other, therefore, anions attracted by the Anode and cathode attracted by the Cathode.

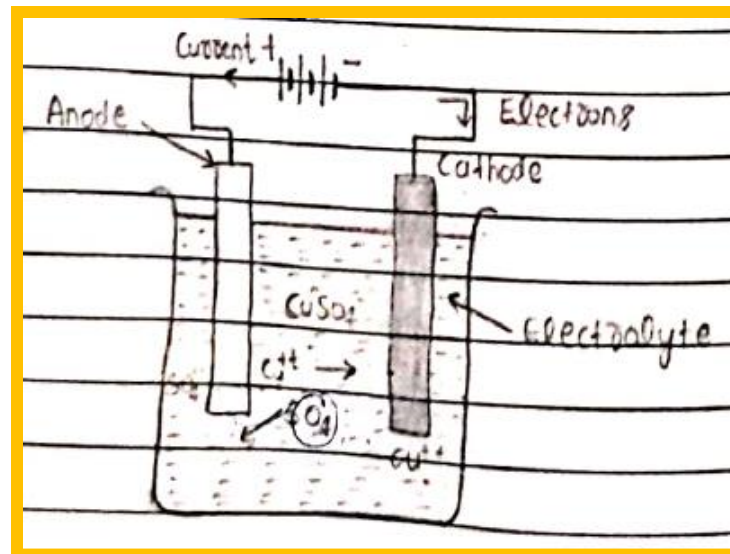

For example, when copper sulphate ( $\text{CuSO}_4$ ) is dissolved in water, immediately molecules of  $\text{CuSO}_4$  break up into positively charged Copper ions & negatively charged sulphate ions. If two electrodes are dipped in such a solution and a potential difference is applied b/w them as shown in figure. The positively charged copper ions will move towards the Cathode and the negatively charged Sulphate ions will move towards the anode, it will give out two electrons and become ( $\text{So}_4$ ) radical. This  $\text{So}_4$  radical is unstable it reacts with water & produces oxygen which will be given up at the anode and also sulphuric acid which will get dissolved in water. If the anode is a copper plate,  $\text{H}_2\text{So}_4$  will react with it produce copper sulphate, Thus, the copper will be dissolved from the anode to form copper sulphate. The strength of the electrolyte shall remain the same.

1. When copper sulphate is dissolved in water

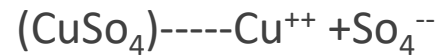

2. When  $\text{H}_2\text{So}_4$  reacts with anode (which is made of copper)

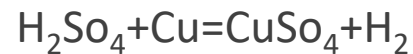

(This copper gets deposited on the article to be electroplated).

In the Process of Electro-deposition, the operations which are involved in the electroplating process are:-

- (1) Cleaning of surface.
- (2) Deposition of metal.
- (3) Polishing and buffing.

### **1. Cleaning of Surface:**

Electroplating is always done a clean surface. So, the object to be electroplated is thoroughly cleaned. If it is not done, the deposits, formed are not well adherent to the base and is likely to peel off. So, proper attention must be given for cleaning operation.

## 2. Deposition of Metal

The process of depositing metal over another metal or non-metal by electrolytic process is known as electro-deposition or deposition of metal. The very common example of this is electroplating.

The article to be electroplated is made Cathode in all types of metal deposition processes. The solution or electrolyte is made of the salt of the metal to be deposited and the anode is made of the same metal which can be deposited on the surface of other metals are given below.

- (1) Copper plating.
- (2) Gold plating.
- (3) Silver plating.
- (4) Nickel plating.
- (5) Chromium plating.



### 3. Polishing and Buffing

**Polishing:-** Silver, nickel or chromium plating requires polishing. Polishing is done by mops driven at a peripheral speed of 2000 to 3000 meter minute. Mops may be of leather, canvas or fell. It is important to run these mop at high speed.

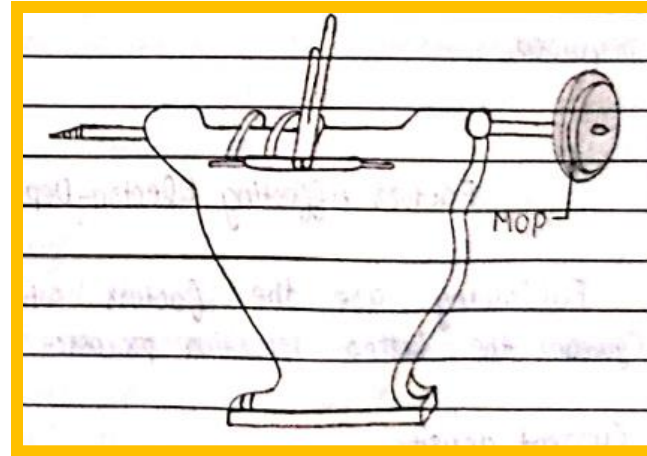

At higher speeds, the metal flows from tops to the valleys of the scratches under high pressure and temperature and produce smooth and shining surface after polishing.

**Buffing :-** Buffing is a general type of polishing process and is done to make the surface of metal, which is to be electroplated more fine.

## EQUIPMENT AND ACCESSORIES USED FOR ELECTROPLATING

The equipment like

**Electrolytic Chamber** : Electrolytic cells typically have one reaction chamber, which contains the electrolyte solution.

**Mops for Polishing** : To get an effective polish, the metal needs to be as flat as it can possibly be without scratches or dings.

**Buffing**: Buffing is the process used to shine metal.

**Chemicals used in electroplating**: Various chemicals like chromium, cadmium and arsenic which are commonly used during electroplating.

**Electroplating Polishing Machine**: It is an electrochemical process that removes material from a metallic work piece.

**DC Supply**: This electric field comes from a DC supply connected to the electrodes.

# Factors Affecting Electro-Deposition

Following are the factors which affects the better deposition process:-

- (1) Current density
- (2) Temperature
- (3) Addition of agents
- (4) Electrolyte Concentration
- (5) Nature of electrolyte
- (6) Nature of the metal upon which deposit is to be made.
- (7) Throwing power

# Galvanizing

Galvanizing is processing in which hot-dip galvanizing is a process of applying a protective zinc coating by dipping product in bath of molten zinc. Zinc plating or electroplating is a process where zinc is applied by using a current of electricity

Applications:-

- (1) To prevent corrosion and rusting
- (2) Power generation & transmission
- (3) Infrastructure development
- (4) Tele communication towers
- (5) Building and construction
- (6) Mining
- (7) Oil and Gas production

# Anodizing

Anodizing is a process in which a thin uniform passive film of oxide is produced artificially by the passage of electric current on the surface of metal. This process is called anodic oxidation. Before anodizing the metal thoroughly cleaned and make it as anode. Aluminium and magnesium are used for making passive film to be coated over the metals.

Application:-

- (1) Used to protect the base metal from corrosion.
- (2) Used to produce decorative articles.

# Electroplating of Non Conducting Materials

The process to perform electroplating on non-conductive materials is called electroless plating.

For electroplating on a non-conducting material, first of all non-conducting material is coated with graphite and then put for electroplating. In this process ions of material which is to be coated on non-conducting material are reduced by reducing agent into neutral atoms for deposition which is known as electroless plating process. Generally two types of electroless plating are used such as copper plating and gold plating.

## MANUFACTURING OF CHEMICALS BY ELECTROLYTIC PROCESS

Production of chemicals is done by electrolysis such as Ammonium Sulphate hydrogen oxygen chlorine caustic soda potassium permanganate. The various applications of electrolysis in the production of chemicals are given as under.

1. Production of hydrogen and oxygen gas by electrolysis of water
2. Production of Caustic Soda

## 1. Production of hydrogen and oxygen gas by electrolysis of water:

- ▶ Gases obtained by this process are of high purity and at a cheap cost because of the low energy consumption.
- ▶ The electrolyte consists of 15-20% solution of caustic soda or its equivalent caustic potash and electrodes are of iron.
- ▶ Sulfuric acid is no longer used.
- ▶ Thus hydrogen and oxygen gases are liberated at cathode and anode respectively and water disappears while the quantity of caustic soda remains constant.
- ▶ It is therefore, necessary to add water to the solution periodically.
- ▶ The voltage requirement is 2-2.2 V per cell during operation and 2.3-2.5 V per cell during starting period.
- ▶ Energy consumption is about 6 kWh per cubic meter of hydrogen and 1/2 cubic meter of oxygen



## 2. Production of Caustic Soda:

- ▶ Its is the oldest process as Diaphragm process.
- ▶ There are a number of variations, but all essentially consist of an anode compartment separated from a cathode compartment by a porous diaphragm which prevents the mechanical mixing of two solutions.
- ▶ Chlorine is formed at the anode, and most of it is developed as a gas, a small part going into solution.
- ▶ Sodium is discharged at the cathode and reacts with hydroxyl ions to form sodium hydroxide and hydrogen gas is liberated at the cathode.
- ▶ Usually, the brine is fed into the anode compartment to resist the flow of hydroxyl ions towards the anode.

## References:

- ✓ [www.google.com](http://www.google.com)
- ✓ <https://www.azom.com/article.aspx?ArticleID=2629>
- ✓ <https://www.sharrettsplating.com/blog/electroplating-non-conductive-materials/#electroless-plating>
- ✓ [https://onlineaavedan.com/study\\_material/1546513584.pdf](https://onlineaavedan.com/study_material/1546513584.pdf)
- ✓ <https://www.yourelectricalguide.com/2017/03/resistance-heating.html>
- ✓ <https://www.theweldingmaster.com/atomic-hydrogen-welding/atomic-hydrogen-welding-2/>
- ✓ [http://www.brainkart.com/article/Induction-heating--Types,-Advantages,-Application\\_13690/](http://www.brainkart.com/article/Induction-heating--Types,-Advantages,-Application_13690/)
- ✓ Textbooks
- ✓ SlideShare
- ✓ Wikipedia
- ✓ Quora
- ✓ UEE, Ishan Publications 2017-2018.

**THANKYOU**

The background features a dark grey area on the left and a complex, layered geometric pattern on the right. The pattern consists of various overlapping triangles and polygons in shades of yellow, gold, and olive green, creating a dynamic, abstract composition.